

SPEAKMAN®

SEF-1821

EYESAVER® FAUCET SPECIFICATIONS

DESCRIPTION

The SEF-1821 Eyesaver® faucet combines a sensor activated gooseneck faucet with an independently operated eyewash. The faucet features a 4" deck plate with thermostatic mixer while the eyewash offers twin aerated sprays and flip-top dust covers.

SPECIFICATIONS

EYEWASH

Activator: Pull handle with graphics

Spray heads: (2) aerated yellow ABS plastic spray outlets with flip-top dust caps

Performance: 2.6 gpm @ 30 psi

Approvals: Meets ANSI Z358.1

FAUCET

Supply: 3/8" compression connections with male threads for hot and cold inlets

Center Distance: 4"

Activator: Sensor AC powered

Performance: 2.2 gpm

Counter thickness: Up to 1 1/4" thick

Approvals: Meets ASME A112.18.1, CSA B125-98

Universal Emergency Sign Included

OPTIONS

- BO Vandal resistant 0.5 gpm flow control
- HS Two (2) Stainless steel flexible supply hoses to supply stops
- LF Laminar flow outlet 2.2 gpm
- NA No aerated eyewash
- ST Serrated tip with vacuum breaker
- TW Addition of SE-370 thermostatic mixing valve
- 8 8" gooseneck spout

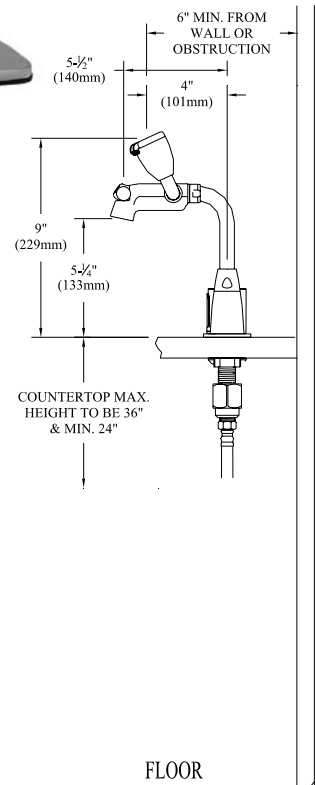
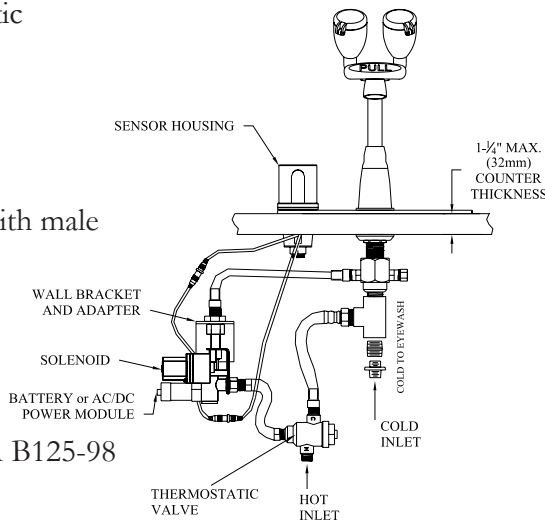

Job Name _____
Location _____
Architect/Engineer _____
Sales Representative _____
Wholesaler _____
Date _____ Model # _____